

PIPING FITTING

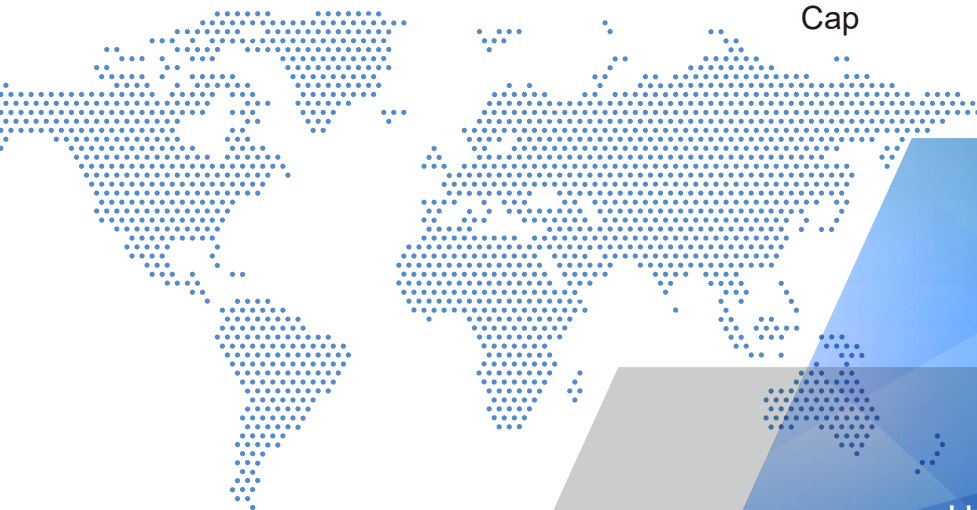
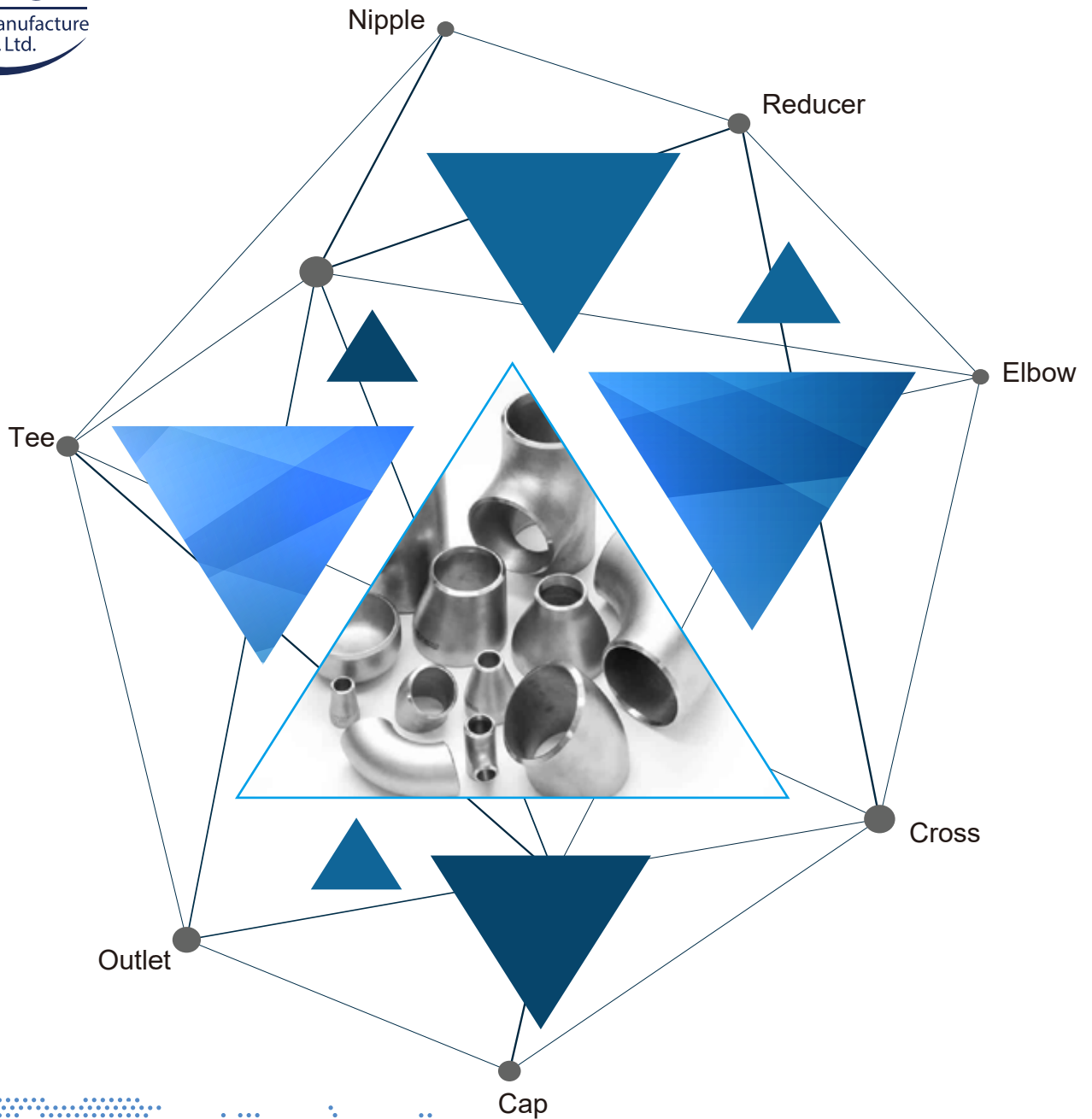

Elite Piping Manufacture Co., Ltd

[Https://bekingpiping.com](https://bekingpiping.com)
Tel/WhatsApp: +86 18618291381
E-mail: elite@elitepiping.com

90° ELBOW

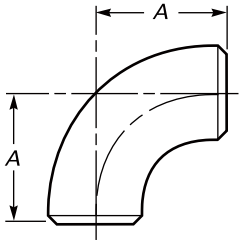

Stainless Steel Butt Weld Elbow



Alloy Steel / Carbon Steel Butt Weld Elbow

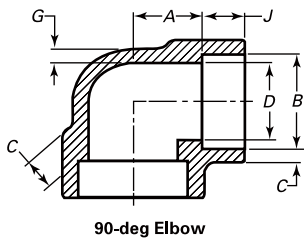

Stainless Steel Socket Forged Elbow



Alloy Steel / Carbon Steel Socket Forged Elbow

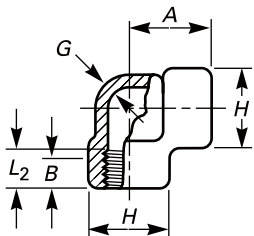

Stainless Steel Threaded Forged Elbow



Alloy Steel / Carbon Steel Threaded Forged Elbow

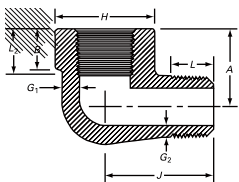

Stainless Steel Forged Threaded Street Elbow



Alloy Steel / Carbon Steel Threaded Forged Street Elbow

45° ELBOW

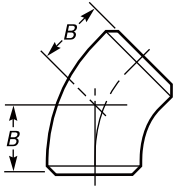

Stainless Steel Butt Weld Elbow



Alloy Steel / Carbon Steel Butt Weld Elbow

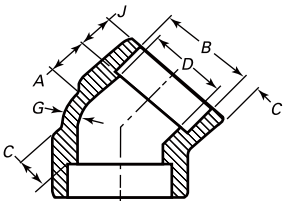

Stainless Steel Socket Forged Elbow



Alloy Steel / Carbon Steel Socket Forged Elbow

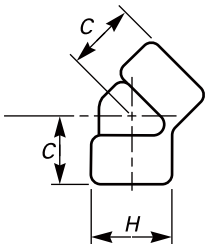

Stainless Steel Threaded Forged Elbow



Alloy Steel / Carbon Steel Threaded Forged Elbow

180° ELBOW

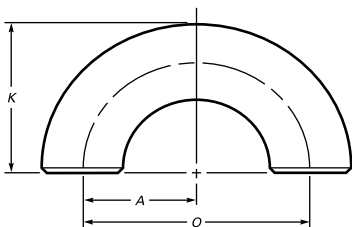

Stainless Steel Butt Weld Elbow



Alloy Steel / Carbon Steel Butt Weld Elbow

CAP

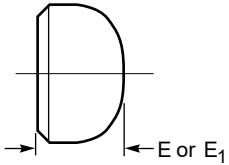

Stainless Steel Butt Weld Cap



Alloy Steel / Carbon Steel
Butt Weld Cap

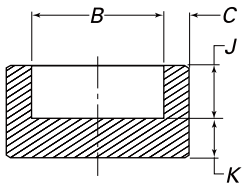

Stainless Steel Socket Forged Cap



Alloy Steel / Carbon Steel
Socket Forged Cap

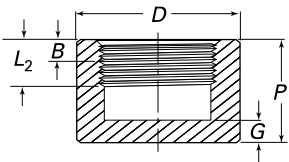

Stainless Steel Threaded Forged Cap



Alloy Steel / Carbon Steel
Threaded Forged Cap

TEE

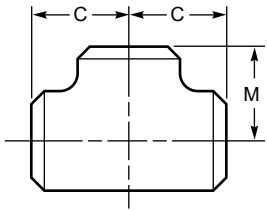

Stainless Steel Butt Weld Tee



Alloy Steel / Carbon Steel
Butt Weld Tee

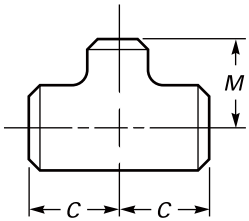

Stainless Steel Butt Weld unequal Tee



Alloy Steel / Carbon Steel
Butt Weld unequal Tee

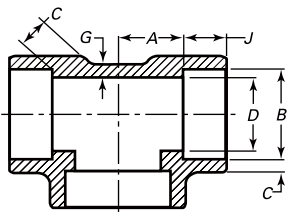

Stainless Steel Socket Forged Tee



Alloy Steel / Carbon Steel
Socket Forged Tee

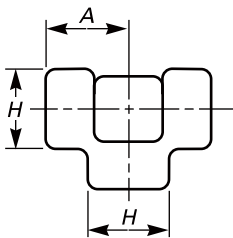

Stainless Steel Threaded Forged Tee



Alloy Steel / Carbon Steel
Threaded Forged Tee

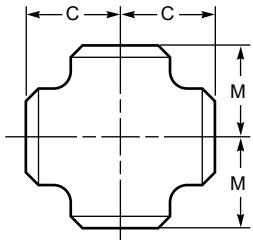

Stainless Steel Butt Weld Cross



Alloy Steel / Carbon Steel
Butt Weld Cross

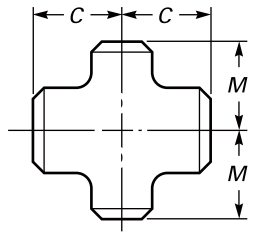

Stainless Steel Butt Weld unequal Cross



Alloy Steel / Carbon Steel
Butt Weld unequal Cross

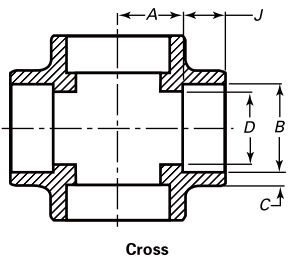

Stainless Steel Socket Forged Cross



Alloy Steel / Carbon Steel
Socket Forged Cross

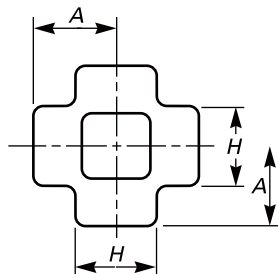

Stainless Steel Threaded Forged Cross



Alloy Steel / Carbon Steel
Threaded Forged Cross

REDUCER

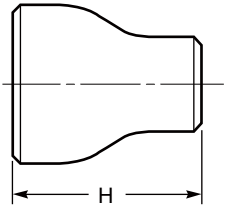

Stainless Steel Butt Weld Reducer



Alloy Steel / Carbon Steel Butt Weld Reducer

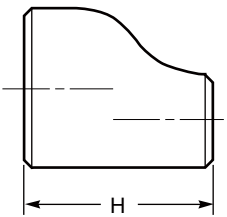

Stainless Steel Butt Weld Eccentric Reducer



Alloy Steel / Carbon Steel Butt Weld Eccentric Reducer

STUB END

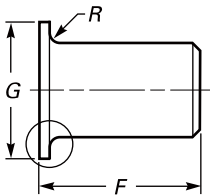

Stainless Steel Butt Weld Stub End



Alloy Steel / Carbon Steel Butt Weld Stub End

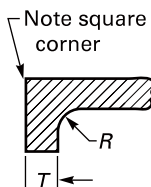

Enlarged Section of Lap

COUPLING

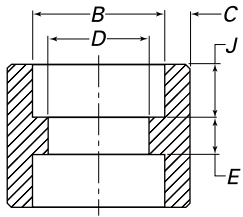

Stainless Steel Socket Forged Coupling



Alloy Steel / Carbon Steel Socket Forged Coupling

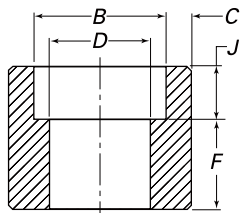

Stainless Steel Socket Forged Half-Coupling



Alloy Steel / Carbon Steel Socket Forged Half-Coupling

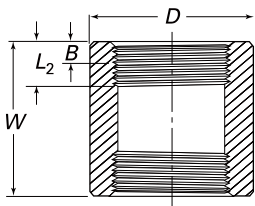

Stainless Steel Threaded Forged Coupling



Alloy Steel / Carbon Steel Threaded Forged Coupling

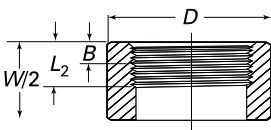

Stainless Steel Threaded Forged Half-Coupling



Alloy Steel / Carbon Steel Threaded Forged Half-Coupling

BUSHING

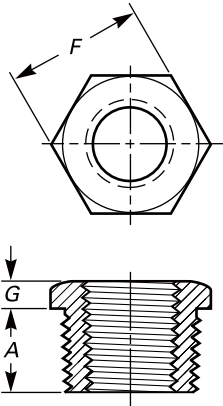

Stainless Steel Threaded Forged Hex Head Bushing



Alloy Steel / Carbon Steel Threaded Forged Hex Head Bushing

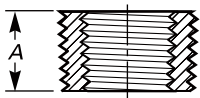

Stainless Steel Threaded Forged Flush Bushing



Alloy Steel / Carbon Steel Threaded Forged Flush Bushing

BOSS

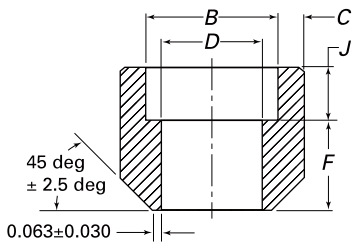

Stainless Steel Socket Forged Boss



Alloy Steel / Carbon Steel Socket Forged Boss

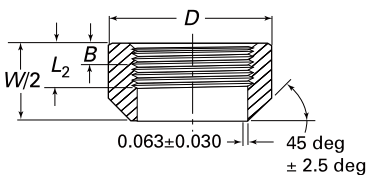

Stainless Steel Threaded Forged Boss



Alloy Steel / Carbon Steel Threaded Forged Boss

PLUG

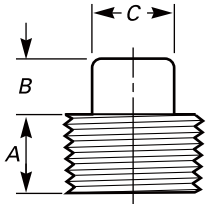

Stainless Steel Threaded Forged Square Head Plug



Alloy Steel / Carbon Steel Threaded Forged Square Head Plug

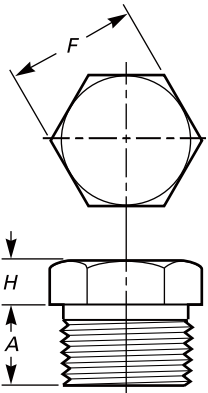

Stainless Steel Threaded Forged Hex Head Plug



Alloy Steel / Carbon Steel Threaded Forged Hex Head Plug

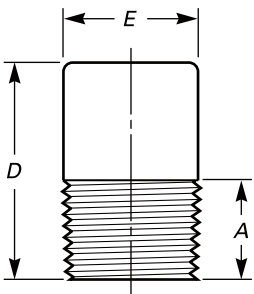

Stainless Steel Threaded Forged Round Head Plug



Alloy Steel / Carbon Steel Threaded Forged Round Head Plug

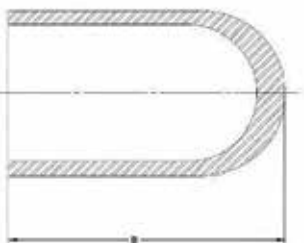

Stainless Steel Threaded Forged Bull Plug



Alloy Steel / Carbon Steel Threaded Forged Bull Plug

45° BRANCH OUTLET

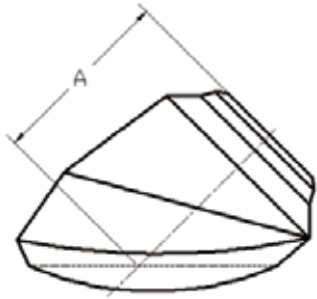

Stainless Steel Butt Weld
45° Branch Outlet



Alloy Steel / Carbon Steel Butt Weld
45° Branch Outlet

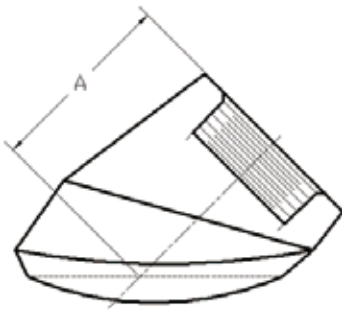

Stainless Steel Threaded Forged
45° Branch Outlet



Alloy Steel / Carbon Steel Threaded
Forged 45° Branch Outlet

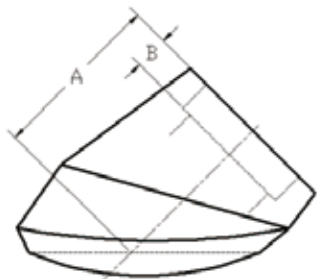

Stainless Steel Socket Forged
45° Branch Outlet



Alloy Steel / Carbon Steel Socket
Forged 45° Branch Outlet

90° BRANCH OUTLET

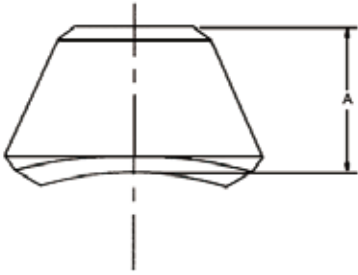

Stainless Steel Butt Weld
90° Branch Outlet



Alloy Steel / Carbon Steel Butt Weld
90° Branch Outlet

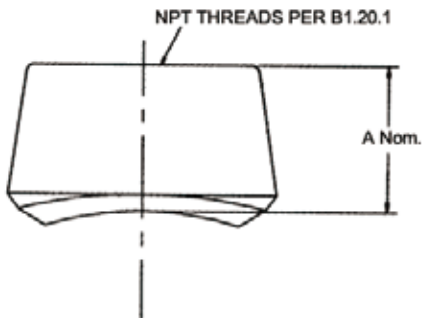

Stainless Steel Threaded Forged
90° Branch Outlet



Alloy Steel / Carbon Steel Threaded
Forged 90° Branch Outlet

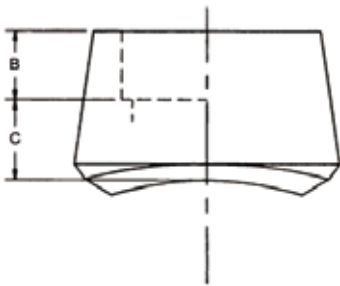

Stainless Steel Socket Forged
90° Branch Outlet



Alloy Steel / Carbon Steel Socket
Forged 90° Branch Outlet

Union

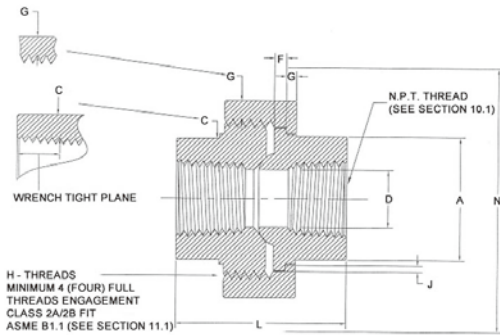

Stainless Steel Threaded Forged Union



Alloy Steel / Carbon Steel Threaded Forged Union

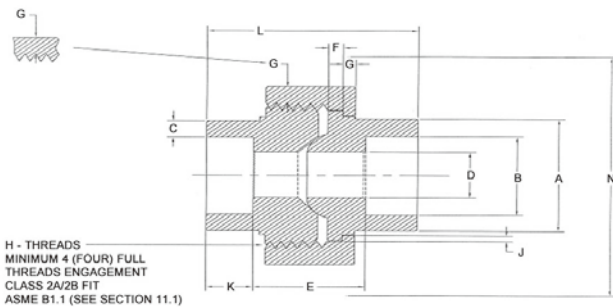

Stainless Steel Socket Forged Union



Alloy Steel / Carbon Steel Socket Forged Union

COUPLER

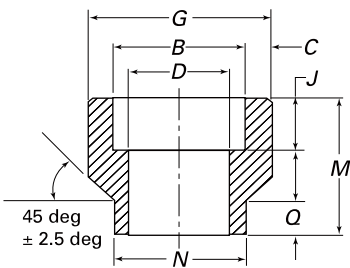

Carbon Steel Socket Forged Coupler



Alloy Steel / Carbon Steel Socket Forged Coupler

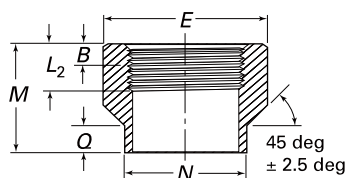

Stainless Steel Threaded Forged Coupler



Alloy Steel / Carbon Steel Threaded Forged Coupler

SCREWED NIPPLE

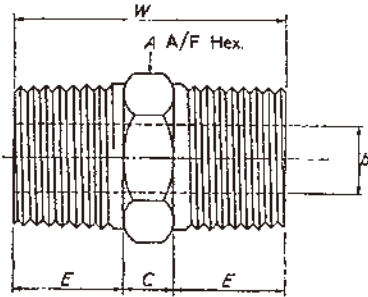

Stainless Steel Threaded Forged Equal Screwed Hexagonal Nipple



Alloy Steel / Carbon Steel Threaded Forged Equal Hexagonal Nipple

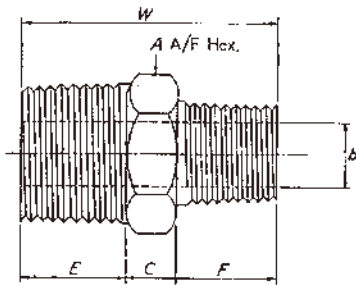

Stainless Steel Threaded Forged Reducing Hexagonal Nipple



Alloy Steel / Carbon Steel Threaded Forged Reducing Hexagonal Nipple

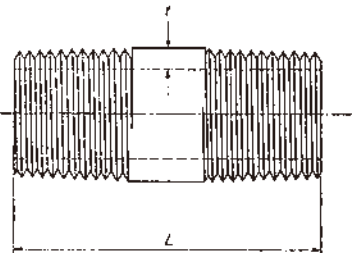

Stainless Steel Threaded Forged Round Nipple



Alloy Steel / Carbon Steel Threaded Forged Round Nipple

SWAGED NIPPLE

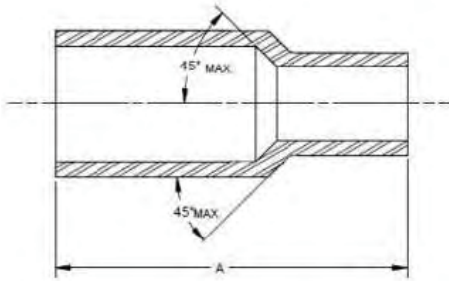

Stainless Steel Threaded Forged Concentric Swaged Nipple



Alloy Steel / Carbon Steel Threaded Forged Concentric Swaged Nipple

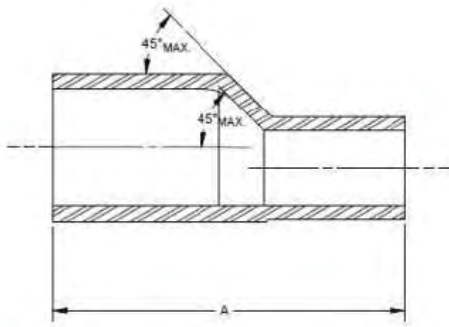

Stainless Steel Threaded Forged Swaged Eccentric Nipple



Alloy Steel / Carbon Steel Threaded Forged Swaged Eccentric Nipple

MATERIAL STANDARD

Pipe	Fittings	Forgings
Carbon Steel		
ASTM A53 GRADE B	ASTM A234 WPB	ASTM A105N
ASTM A106 GRADE B	ASTM A234 WPB	ASTM A105N
API 5L GRADE B	ASTM A234 WPB	ASTM A105N
API 5L GRADE X 42/46/52/56/60/65/70	ASTM A860 WPHY 42/46/52/56/60/65/70	ASTM A694 F42/46/52/56/60/65/70
ASTM A333 GRADE 3	ASTM A420 WPL3	ASTM A350 LF3
ASTM A333 GRADE 6	ASTM A420 WPL6	ASTM A350 LF2
Stainless Steel		
ASTM A312 TP 304	ASTM A403 WP 304	ASTM A182 F304
ASTM A312 TP 304L	ASTM A403 WP 304L	ASTM A182 F304L
ASTM A312 TP 304H	ASTM A403 WP 304H	ASTM A182 F304H
ASTM A312 TP 316	ASTM A403 WP 316	ASTM A182 F316
ASTM A312 TP 316L	ASTM A403 WP 316L	ASTM A182 F316L
ASTM A312 TP 317	ASTM A403 WP 317	ASTM A182 F317
ASTM A312 TP 317L	ASTM A403 WP 317L	ASTM A182 F317L
ASTM A312 TP 321	ASTM A403 WP 321	ASTM A182 F321
ASTM A312 TP 310	ASTM A403 WP 310	ASTM A182 F310
ASTM A312 TP 347	ASTM A403 WP 347	ASTM A182 F347
Alloy Steel		
ASTM A335 GRADE P1	ASTM A234 WP1	ASTM A182 F1
ASTM A335 GRADE P5	ASTM A234 WP5	ASTM A182 F5
ASTM A335 GRADE P9	ASTM A234 WP9	ASTM A182 F9
ASTM A335 GRADE P11	ASTM A234 WP11	ASTM A182 F11
ASTM A335 GRADE P22	ASTM A234 WP22	ASTM A182 F22
ASTM A335 GRADE P91	ASTM A234 WP91	ASTM A182 F91
Duplex 6 Mo		
DUPLEX ASTM A790 UNS S31803	ASTM A815 UNS S31803	ASTM A185 F51
DUPLEX ASTM A790 UNS S32750/60	ASTM A815 UNS S32750/60	ASTM A185 F55
MO ASTM A790 UNS S31254	ASTM A815 UNS S31254	ASTM A185 F44

MANUFACTURE STANDARD

ASME B16.9
ASME B16.11
ASME B16.25
ASME B16.28
ASME B16.49
ASME/ANSI B18.2.1
ASME/ANSI B18.2.2
MSS SP-25
MSS SP-43
MSS SP 75
MSS SP 79
MSS SP-83
MSS SP-87
MSS SP-95
MSS SP-97
AWWA-C208

DIN 2458
DIN 2980

JIS B 2302
JIS B 2311
JIS B 2312
JIS B 2313
JIS B 2316

GOST 17375
GOST-17376
GOST-17378
GOST 17379
TU 1469-006-82932963

HG/T21577
HG/T21631
HG/T21632
HG/T21634
HG/T21635

BS 3799
BS EN1092

ISO 4200
ISO 5251
ISO 6708
ISO 7268
ISO 15590

SH 3408
SH 3409
SH 3410

KS B 1522
KS B 1541
KS B 1542
KS B 1543

BS 1740.1
BS 1965
BS 1640
BS 3799

Also, we could manufacture according to your technical drawings.